

Low  $V_{CE}(\text{sat})$

# 2SA1567

Silicon PNP Epitaxial Planar Transistor (Complement to type 2SC4064)

Application : DC Motor Driver, Chopper Regulator and General Purpose

■ Absolute maximum ratings (Ta=25°C)

Symbol	Ratings	Unit
$V_{CBO}$	-50	V
$V_{CEO}$	-50	V
$V_{EBO}$	-6	V
$I_C$	-12	A
$I_B$	-3	A
$P_C$	35(Tc=25°C)	W
$T_J$	150	°C
$T_{stg}$	-55 to +150	°C

■ Electrical Characteristics (Ta=25°C)

Symbol	Conditions	Ratings	Unit
$I_{CBO}$	$V_{CB}=-50V$	-100max	$\mu A$
$I_{EBO}$	$V_{EB}=-6V$	-100max	$\mu A$
$V_{(BR)CEO}$	$I_C=-25mA$	-50min	V
$h_{FE}$	$V_{CE}=-1V, I_C=-6A$	50min	
$V_{CE(sat)}$	$I_C=-6A, I_B=-0.3A$	-0.35max	V
$f_r$	$V_{CE}=-12V, I_E=0.5A$	40typ	MHz
$COB$	$V_{CB}=-10V, f=1MHz$	330typ	pF

■ Typical Switching Characteristics (Common Emitter)

$V_{CC}$ (V)	$R_L$ ( $\Omega$ )	$I_C$ (A)	$V_{BB1}$ (V)	$V_{BB2}$ (V)	$I_{B1}$ (mA)	$I_{B2}$ (mA)	$t_{on}$ ( $\mu s$ )	$t_{stg}$ ( $\mu s$ )	$t_f$ ( $\mu s$ )
-24	4	-6	-10	5	-120	120	0.4typ	0.4typ	0.2typ

External Dimensions FM20 (TO220F)

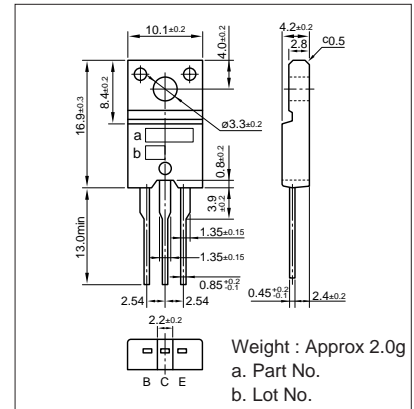

$I_C-V_{CE}$  Characteristics (Typical)

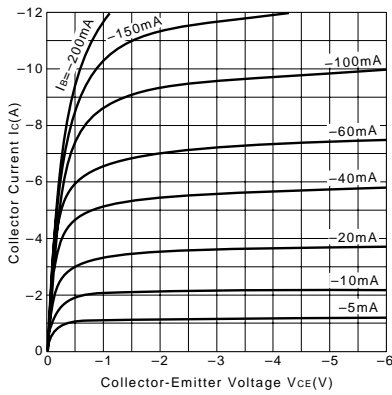

$V_{CE(sat)}-I_B$  Characteristics (Typical)

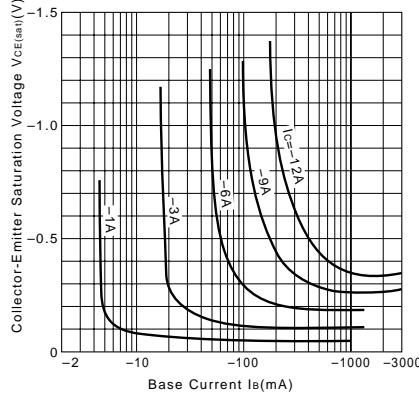

$I_C-V_{BE}$  Temperature Characteristics (Typical)

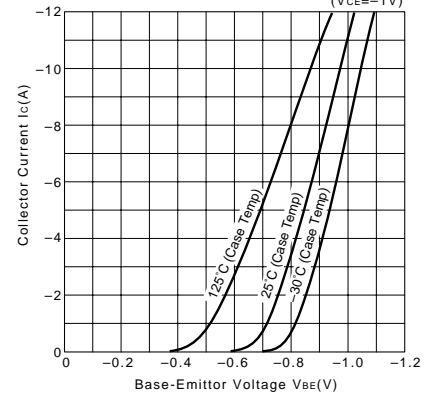

$h_{FE}-I_C$  Characteristics (Typical)

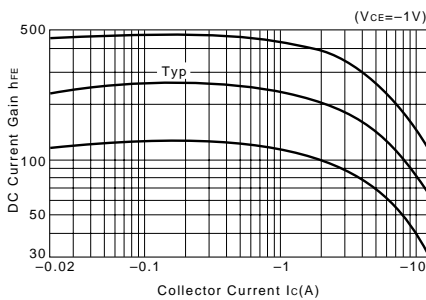

$h_{FE}-I_C$  Temperature Characteristics (Typical)

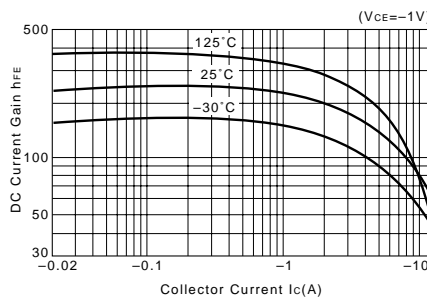

$\theta_{j-a}-t$  Characteristics

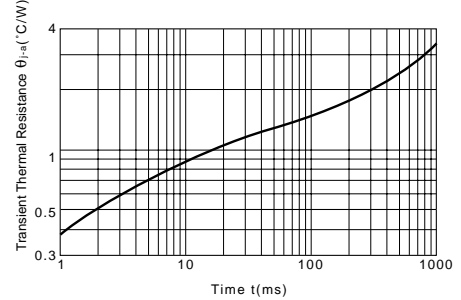

$f_T-I_E$  Characteristics (Typical)

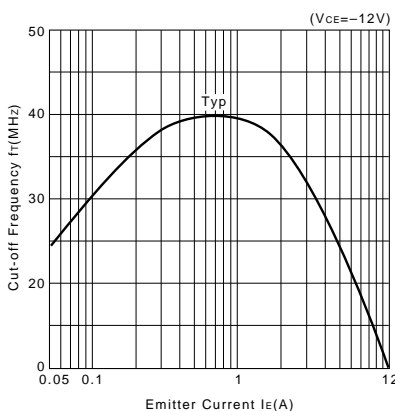

Safe Operating Area (Single Pulse)

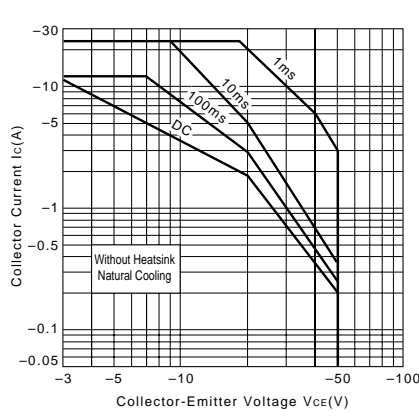

$P_C-T_a$  Derating

